

Section 2
WYDOT (ASTM) Test Methods



WYDOT Concrete Training & Certification Seminar

2-1

ASTM Test Methods

(See ASTM Loaner Book for ASTM Standards)

WYDOT 478.0

ASTM C1064 Standard Test Method for Temperature of Freshly Mixed Portland Cement Concrete

WYDOT 477.0

ASTM C172 Standard Practice for Sampling Freshly Mixed Concrete

WYDOT 480.0

ASTM C143 Standard Test Method for Slump of Hydraulic Cement Concrete

2-2

WYDOT 479.0

ASTM C138 Standard Test Method for Unit Weight, Yield, and Air Content (Gravimetric) of Concrete

WYDOT 481.0



ASTM C231 Standard Test Method for Air Content of Freshly Mixed Concrete by Pressure Method

WYDOT 485.0

ASTM C31 Standard Practice for Making and Curing Concrete Test Specimens in the Field (cylinders & beams)

Warning—Fresh hydraulic cementitious mixtures are caustic and may cause chemical burns to skin and tissue upon prolonged exposure.

Temperature of Fresh Concrete ASTM C1064

Temperature Measuring Device (TMD)

1. Measure accurately to $\pm 1^\circ\text{F}$ (Para. 5.2)
2. Range **30° to 120°F**
3. Allows **3 in.** or more immersion into concrete
4. Check accuracy of TMD at least **annually** or whenever there is a **question of accuracy**. (Para 6.1)

Container (Para. 5.1 & 7.1)

1. Must be large enough to provide **3 in.** of concrete in all directions around sensor
2. Composite concrete sample not required

If nominal size aggregate greater than 3 in., may require up to 20 minutes for mix temperature to stabilize. (Para. 4.2)

8.0 Procedure

1. Place temperature measuring device (TMD) in concrete so the sensing portion is submerged a minimum of 3 in. (Para. 8.1)
2. Gently press concrete around TMD so the ambient (outside) air temperature does not influence the measured concrete temperature. (Para. 8.1)
3. Leave TMD in concrete for at least 2 min but not more than 5 min. (Para. 8.2)
4. Read and record fresh concrete temperature to nearest 1°F. Do not remove TMD from concrete when reading temperature. (Para. 8.2)
5. Report measured temperature of freshly mixed concrete to the nearest 1°F. (Para. 9.1)

2-5

Sampling Fresh Concrete ASTM C172



Composite samples are required by this practice

(blended concrete sample made up of different individual samples)

Where do we take the sample?

Point of discharge (back of truck or delivery vehicle) – **ASTM DEFAULT LOCATION**

Point of placement (end of pump hose, conveyor belt, etc.) – **SEE WYDOT PROJECT SPECIFICATION** 2-6

Sampling Fresh Concrete – Performance Exam

1. What must occur before a sample of concrete can be taken from a revolving drum mixer? (Para. 5.2.3)
 - **All water and admixtures must be added to the mixer**
2. When sampling from a stationary or revolving drum mixer, what is collected and when is it taken during discharge? (Para. 5.2.1 and 5.2.3)
 - **Two or more portions of concrete**
 - **At regularly spaced intervals**
 - **From the middle of the batch**
3. How are the sample portions obtained from the discharge stream of a stationary or revolving drum mixer? (Para. 5.2.1 and 5.2.3)
 - **Repeatedly pass a receptacle through the entire discharge stream**
 - **Completely divert the discharge stream into a sample container**
4. Describe the procedure for collecting a sample from a paving mixer. (Para. 5.2.2)
 - **Discharge the contents of the paving mixer**
 - **Obtain samples from at least five (5) different portions of the pile**
5. What is the minimum size for a sample when strength test specimens are to be molded? (Para. 5.1)
 - **1 ft³**

6. What is the maximum allowable time between obtaining the first and final portions of the composite sample? (Para. 4.1)
 - **15 min**
7. What action is required after the individual concrete samples have been transported to the place where tests are to be performed? (Para. 4.1.1)
 - **Combine and remix the samples with a shovel**
8. What should be done if the concrete contains aggregate larger than is appropriate for the size of the molds or equipment being used? (Para. 6.1)
 - **Wet sieving**
9. Start the tests for slump, temperature, and air content within how many minutes after obtaining the final portion of the composite sample? (Para. 4.1.2)
 - **5 min**
10. Start molding specimens for strength tests within how many minutes after fabricating the composite sample? (Para. 4.1.2)
 - **15 min**
11. From what must the concrete sample be protected? (Para. 4.1.2)
 - **Sun, wind, and rapid evaporation**
 - **Contamination**

Slump

ASTM C143



Purpose of the slump test is to determine the consistency of the concrete. This is a measure of the relative fluidity or mobility of the concrete mixture. Slump does not measure the water content or workability of the concrete.

4.2 This test method is considered applicable to plastic concrete having **coarse aggregate up to 1½ in. in size.**

If the coarse aggregate is larger than **1½ in.** in size, the test method is applicable when it is performed on the fraction of concrete passing a **1½ in.** sieve, with the larger aggregate being removed in accordance with the section titled “Additional Procedure for Large Maximum Size Aggregate Concrete” in Practice C172.

2-9



Note 2. Concretes having slumps less than $\frac{1}{2}$ in. may not be adequately plastic and concretes having slumps greater than about 9 in. may not be adequately cohesive for this test to have significance.

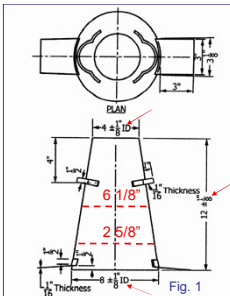

Note 5. One third of the volume of the slump mold fills it to a depth of 2 5/8 in.; two thirds of the volume fills it to a depth of 6 1/8 in.

5.1 The mold shall be free from dents, deformation, or adhered mortar.



5.2 Tamping Rod:
Around, smooth, straight steel rod, with a $\frac{5}{8}$ in. \pm $\frac{1}{16}$ in diameter.

Length of the tamping rod shall be at least 4 in. greater than the depth of the mold in which rodding is being performed, but not greater than 24 in. in overall length.

The rod shall have the tamping end or both ends rounded to a hemispherical tip of the same diameter as the rod.

5.3 Measuring Device:
ruler, metal roll-up tape, etc. marked in $\frac{1}{4}$ in. increments



2-11

7.0 Procedure

1. Dampen the mold. (Para. 7.1)
2. Place the mold on a rigid, flat, level, moist, nonabsorbent surface, free of vibration, that is large enough to contain all of the slumped concrete. (Para. 7.1)
3. Hold the mold firmly in place during filling and cleaning by standing on the two foot pieces on either side of the mold. A base plate with clamps is also acceptable. (Para. 7.1)
4. Using a scoop, fill the mold in three layers, moving the scoop around the perimeter of the mold opening to ensure an even distribution of the concrete.

For the first layer:

- A. Fill the mold to approximately 1/3 of its volume (2-5/8 in.).
- B. Rod the layer 25 times throughout its depth with the rounded end of the tamping rod.

2-12

Uniformly distribute the strokes over the cross section of the layer. Incline the rod slightly, starting near the perimeter, and progress with vertical strokes spirally toward the center. (Para. 7.2)

25 rods per layer



5. For the second layer:

A. Fill the mold to approximately 2/3 of its volume 6-1/8 in. (Para. 7.1 and Note 5)

B. Rod the layer 25 times uniformly over the cross section, with the rounded end of the rod.

Rod through the layer and into the layer below approximately 1 in. Uniformly distribute the strokes over the cross section of the layer. (Para. 7.2)



2-14

6. For the third layer:

A. Heap concrete above the top of the mold. (Para. 7.3)

B. Rod the layer 25 times uniformly over the cross section, with the rounded end of the rod. Rod through the layer and into the layer below approximately 1 in. Uniformly distribute the strokes over the cross section of the layer. (Para. 7.2)



2-15

C. Should rodding the layer result in the concrete falling below the top of the mold, add concrete to keep an excess above the mold. Continue the rodding count from the value reached before concrete was added to the mold. (Para. 7.3)

7. Strike off the top surface of concrete with the tamping rod in a screeding and rolling motion. (Para. 7.3)

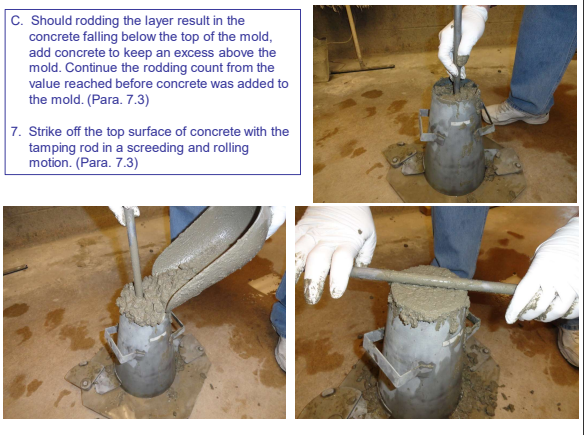

8. While maintaining downward pressure, remove any concrete which collected around the base of the mold during strike off. (Para. 7.3)



9. Immediately remove the mold by raising it in a steady, vertical direction. There should be no lateral or torsional motion of the mold while lifting. Lift the mold off the concrete, a distance of 12 in. in 5 ± 2 s. (Para. 7.3)

10. Complete the slump test, from the start of filling the mold through the removal of the mold, in $2-1/2$ min. (Para. 7.3)

11. If a decided falling away or shearing off of concrete from one side or portion of the mass occurs, disregard the test and make a new test on another portion of the sample. (Para. 7.4)

12. Immediately measure the slump. This is the vertical distance between the top of the mold and the displaced original center of the top surface of the specimen. (Para. 7.4)

13. Report the slump to the nearest $1/4$ in. (Para. 8.1)

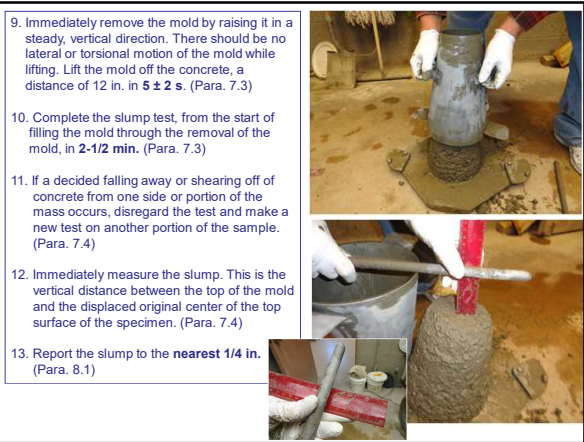

Unit Weight, Yield & Air Content ASTM C138



The density test is a very important tool used to control the quality of freshly-mixed concrete. After a concrete mixture proportion has been established, a change in the concrete's density will indicate a change in one or more of the other concrete performance requirements.

A lower density may indicate 1) that the materials have changed [lower specific gravity], 2) a higher air content, 3) a higher water content, 4) a change in the proportions of ingredients, and/or 5) a lower cement content.

A lower density from the established concrete mix proportion will generally indicate an over-yeild

2-19

4.1 Balance A balance or scale accurate to 0.1 lb or to within 0.3 % of the test load, whichever is greater, at any point within the range of use.

4.2 Tamping Rod:
Around, smooth, straight steel rod, with a 5/8 in. ± 1/16 in. in diameter.

Length of the tamping rod shall be at least 4 in. greater than the depth of the mold in which rodding is being performed, but not greater than 24 in. in overall length.

The rod shall have the tamping end or both ends rounded to a hemispherical tip of the same diameter as the rod.

No wet sieving for larger aggregate sizes... get a bigger measurer

4.5 Strike-Off Plate A flat rectangular metal plate at least 1/4 in. thick or a glass or acrylic plate at least 1/2 in. thick with a length and width at least 2 in. greater than the diameter of the measure with which it is to be used. The edges of the plate shall be straight and smooth within a tolerance of 1/16 in.

4.6 Mallet A mallet (with a rubber or rawhide head) having a mass of 1.25 ± 0.50 lb for use with measures of 0.5 ft³ or smaller, and a mallet having a mass of 2.25 ± 0.50 lb for use with measures larger than 0.5 ft³.

TABLE 1 Capacity of Measures

Nominal Maximum Size of Coarse Aggregate		Capacity of Measure ^a	
mm	[in.]	L	[ft ³]
25.0	[1]	6	[0.2]
37.5	[1½]	11	[0.4]
50	[2]	14	[0.5]
75	[3]	28	[1.0]
112	[4½]	70	[2.5]
150	[6]	100	[3.5]

^aThe indicated size of measure shall be used to test concrete containing aggregates of a nominal maximum size equal to or smaller than that listed. The actual volume of the measure shall be at least 95 % of the nominal volume listed.

6.1 Consolidation Rod concretes with a slump greater than 3 in. Rod or vibrate concrete with a slump of 1 to 3 in. Consolidate concretes with a slump less than 1 in. by vibration.

Density & Air Test Performed in Sequence



2-21

6.0 Procedure

1. Dampen the interior of the measure and remove any standing water from the bottom of the measure. (Para 6.2)
2. Determine the mass (lb) of the empty measure to be used and place it on a flat, level, firm surface. (Para 6.2)
3. Using a scoop, place the concrete in the measure in three layers of approximately equal volume, moving the scoop around the perimeter of the measure opening to ensure an even distribution of the concrete.

For the first layer:

A. Fill the measure to approximately 1/3 of its volume. (Para. 6.3)

B. Rod the layer 25 times, uniformly over the cross section, with the rounded end of the rod. Rod the layer throughout its depth using care not to damage the bottom of the measure. (Para. 6.3)



- C. Tap the sides of the measure 10 to 15 times with the mallet to close any voids left by the tamping rod and to release any large bubbles of air. (Para. 6.3)



2-23

4. For the second layer:

A. Fill the measure to approximately 2/3 of its volume. (Para. 6.3)

B. Rod the layer 25 times, uniformly over the cross section, with the rounded end of the rod. Rod through the layer and into the layer below approximately 1 in. (Para. 6.3)

C. Tap the sides of the measure 10 to 15 times with the mallet to close any voids left by the tamping rod and to release any large bubbles of air. (Para. 6.3)



5. For the third layer:
A. Add material so as to avoid overfilling. (Para. 6.3)
B. Rod the layer 25 times, uniformly over the cross section, with the rounded end of the rod. Rod through the layer and into the layer below approximately 1in. (Para. 6.3)
C. Tap the sides of the measure 10 to 15 times with the mallet to close any voids left by the tamping rod and to release any large bubbles of air. (Para. 6.3)

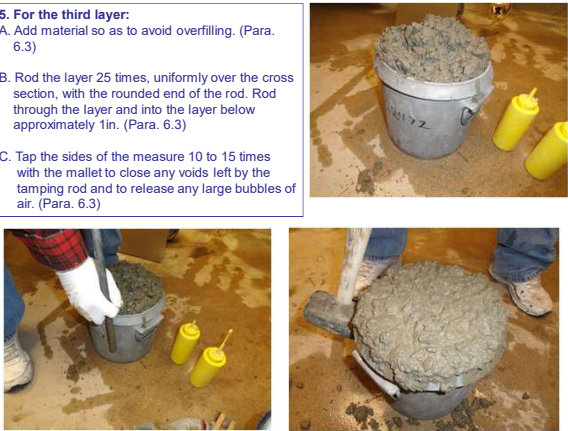

The first photograph shows a bucket filled with concrete. The second photograph shows a person using a tamping rod to compact the concrete in the bucket. The third photograph shows a person tapping the sides of the bucket with a mallet to settle the concrete.

6. After consolidating the third layer, an approximate 1/8 in. of excess concrete above the top of the measure is considered optimal. Representative material can be added or removed as needed prior to strike-off. (Para. 6.5)

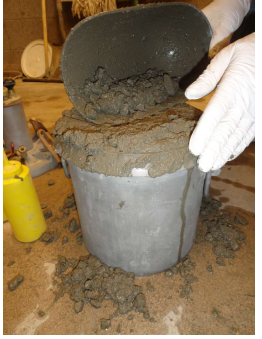

The photograph shows a person using a shovel to add a layer of concrete to the top of the bucket, creating an excess layer above the rim.

7. Strike-off the top surface of the concrete and finish it smoothly with the flat strike-off plate, leaving the measure just level full:
A. Press the strike-off plate on the top surface of the measure to cover 2/3 of the surface. Withdraw the plate with a sawing motion to finish only the area originally covered. (Para. 6.6)

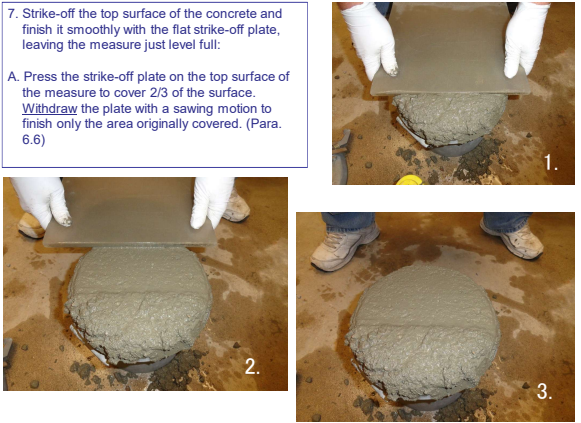

The first photograph shows a person pressing a flat plate onto the top of the concrete in the bucket. The second photograph shows the plate being drawn across the surface. The third photograph shows the finished, level surface of the concrete.

B. Place the plate on top of the measure to cover the original 2/3 of the surface. Advance it with a vertical pressure and a sawing motion to cover the whole surface of the measure. Continue to advance the plate until it slides completely off the measure. (Para. 6.6)

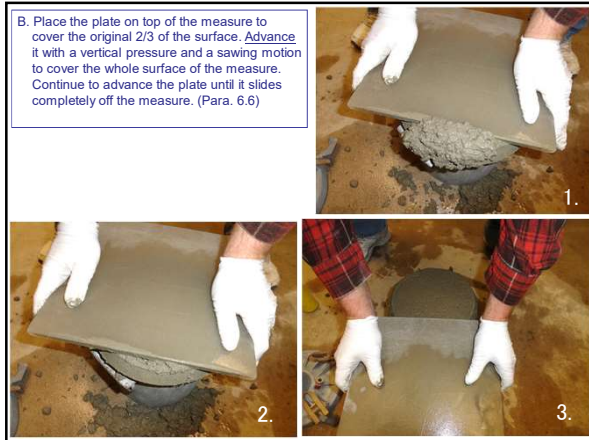

1.

2.

3.

C. Incline the plate and perform several strokes with the edge of the plate to produce a smooth finish. (Para. 6.6)

8. Completely clean the exterior of the measure and determine the mass of the measure filled with concrete. (Para. 6.7)

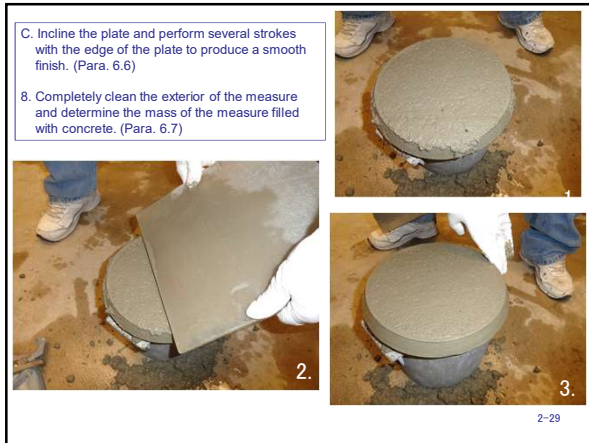

2.

3.

2-29

9. Report the density (unit weight) of the concrete to the nearest 0.1lb/ft³. (Para. 7.1 and 8.1.4)



Empty Measurer (Mm) = 7.3 lb
Mm + concrete = 43.0 lb
Mass of concrete = 35.7 lb

2-30

Unit Weight

Definition: Weight per unit volume

$$D = (M_c - M_m) / V_m \quad \text{Eq. 1}$$

where

- D = Unit weight or density, lb/ft³
- M_c = Mass of measurer (container) filled with concrete, lb
- M_m = Mass of measure (container), lb
- V_m = Volume of measure (container), ft³

- Typical Fresh Concrete Values: 140 to 150 lb/ft³ (pcf)
- Unit Weight of hardened concrete will always be less than unit weight of fresh concrete because of water loss.

2-31

Calculating Unit Weight & Yield

Example

Empty Container
 $M_m = 7.3$ lb Volume = 0.247 ft³

Mass of Container & Fresh Concrete
 $M_c = 43.0$ lb

$$D = \frac{(43.0 \text{ lb} - 7.3 \text{ lb})}{0.247 \text{ ft}^3} = 144.5 \text{ lb/ft}^3$$

Volume of measure to nearest 0.001 ft³
 Density of concrete to nearest 0.1 lb/ft³
 Yield of concrete to nearest 0.1 yd³
 Relative Yield to nearest 0.01

2-32

A low unit weight may indicate ...

- Materials have changed (lower specific gravity)
- Higher air content ←
- Higher water content
- Change in proportions of ingredients
- Lower cement content
- Mix may have been diluted to produce a greater volume – over yielding

If mix is over yielding, then low strength possible.

2-33

Yield

Definition: Volume of concrete represented by the weight of concrete materials batched

$$Y \text{ (yd}^3\text{)} = \frac{M}{(D \times 27)} \quad \text{Eq. 3}$$

where

Y = Yield (yd³)

M = sum of all materials batched including aggregates, cement, fly ash, water, etc.(lbs)

D = Unit weight (lb/ft³)

1 yd³ = 27 ft³ (27 used to convert from ft³ to yd³)

2-34

Relative Yield (Ry)

Ratio of the actual volume of concrete obtained to the volume as designed for the batch

$$Ry = Y/Yd \quad \text{Eq. 5}$$

$$Ry = \frac{\text{Vol. of Concrete Produced}}{\text{Vol. of Concrete Batch Designed to Produce}}$$

2-35

Yield & Relative Yield

1. Calculate Total Mass of Materials Batched
from batch ticket (7.0 cuyd order)

Sand	8,432 lb
Rock	12,634 lb
Water/Batch	1,715 lb
Water/Site	76 lb
Cement	4,116 lb
M (total mass) =	26,973 lb (for 7 cuyd batch)

2-36

2. Compute Yield Y (ft³)

$$Y \text{ (ft}^3\text{)} = 26,973 \text{ lbs}/(144.5 \text{ lbs/ft}^3) = 186.7 \text{ ft}^3$$

3. Changing to cubic yards (yd³)

$$Y \text{ (yd}^3\text{)} = \frac{186.7 \text{ cuft}}{27 \text{ ft}^3/\text{yd}^3} = 6.9 \text{ yd}^3$$

4. Compute Relative Yield (Ry)

$$Ry = \frac{\text{Vol. Produced}}{\text{Designed Vol.}} = 6.9/7.0 = 0.986 = 0.99$$

Since 0.99 is less than 1.0, mix is under yielding! 2-37

Items that affect yield:

1. Accuracy of water meter
2. Accuracy of scale
3. Aggregate moisture content
4. Aggregate absorption
5. Specific gravity of aggregate
6. Air content

2-38

Over or Under Yielding

If yield is off by more than ± 2% for two consecutive tests then WYDOT says ...

1. Contact the lab and have mix design checked
2. Check batch plant (calibrations of scale & water meter, aggregate moisture contents, etc.)
3. Check transport and/or ready mix trucks to ensure compliance with specifications, proper clean-out and water meters, etc.
4. Check air content
5. Compare average net or free water per cubic yard from T109 placing report with Lab design
6. If not resolved, submit samples to Lab for further testing and new mix design

2-39

**Air Content
Pressure Method
ASTM C231**

Test method can be used to determine the air content of normal and heavyweight concretes. It cannot be used with highly porous aggregates, such as found in lightweight concrete. This test method will determine the amount of both the entrained and entrapped air voids in the concrete.



1.2 This test method is intended for use with concretes and mortars made with relatively dense aggregates for which the aggregate correction factor can be satisfactorily determined by the technique described in Section 6. It is not applicable to concretes made with lightweight aggregates, air-cooled blast furnace slag, or aggregates of high porosity. In these cases, Test Method C173 should be used.

3.1 This test method covers the determination of the air content of freshly mixed concrete. The test determines the air content of freshly mixed concrete exclusive of any air that may exist inside voids within aggregate particles. For this reason, it is applicable to concrete made with relatively dense aggregate particles and requires determination of the aggregate correction factor (see 6.1 and 9.1).

2-40

Type-B Meters

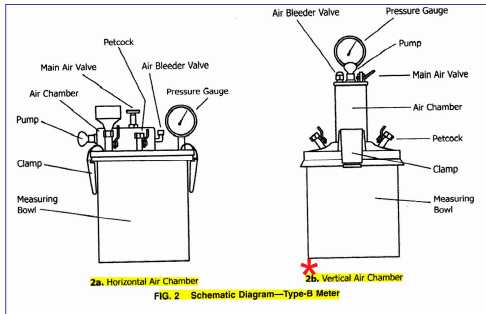

Ignore Type-A Meter in ASTM C231

2-41

4.9 Tamping Rod:

Around, smooth, straight steel rod, with a 5/8 in. \pm 1/16 in diameter.

Length of the tamping rod shall be at least 4 in. greater than the depth of the mold in which rodding is being performed, but not greater than 24 in. in overall length.

The rod shall have the tamping end or both ends rounded to a hemispherical tip of the same diameter as the rod.

4.10 Mallet A mallet (with a rubber or rawhide head) having a mass of 1.25 ± 0.50 lb for use with measures of 0.5 ft³ or smaller, and a mallet having a mass of 2.25 ± 0.50 lb for use with measures larger than 0.5 ft³.

4.11 Strike-Off Bar A flat straight bar of steel or other suitable metal at least 1/8 in. thick and 3/4 in. wide and 12 in. long.

4.12 Strike-Off Plate A flat rectangular metal plate at least 1/4 in. thick or a glass or acrylic plate at least 1/2 in. thick with a length and width at least 2 in. greater than the diameter of the measure with which it is to be used. The edges of the plate shall be straight and smooth within a tolerance of 1/16 in.

7.1 [Max Size Aggregate] If the concrete contains coarse aggregate particles that would be retained on a 2 in. sieve, wet-sieve a sufficient amount of the representative sample over a 1 1/2 in. sieve, as described in Practice C172, to yield sufficient material to completely fill the measuring bowl of the size selected for use.

Carry out the wet-sieving operation with the minimum practicable disturbance of the mortar. Make no attempt to wipe adhering mortar from coarse aggregate particles retained on the sieve.

2-42



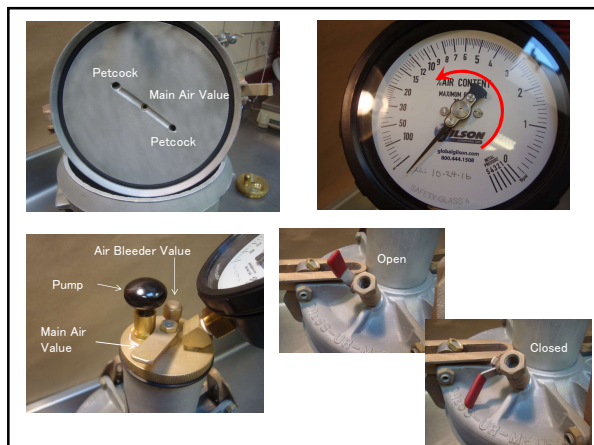

8.0 Procedure
Performed in conjunction with ASTM C138)

6. Thoroughly clean the flange/rim of the measuring bowl and cover assembly. (Para. 8.3.1)
7. Clamp the cover assembly to the measuring bowl ensuring a pressure-tight seal. (Para. 8.3.1)
8. Close the main air valve between the air chamber and measuring bowl. Open both petcocks on the cover. (Para. 8.3.1)



Clean top edge of rim & O-ring

2-45

9. Use a syringe to inject water through one petcock until water emerges from the opposite petcock. Jar the meter gently until all air is expelled from the opposite petcock. (Para. 8.3.1)

10. Close the air bleeder valve and pump air into the air chamber until the hand on the dial gauge is on the initial pressure line. Allow a few seconds for the compressed air to cool. (Para. 8.3.2)

11. Stabilize the gauge hand at the initial pressure line by bleeding, pumping, and lightly tapping the gauge by hand. (Para. 8.3.2)



Tapping Hand



Set initial reading to 3 past 0

2-46

12. Close both petcocks. (Para. 8.3.2)

13. Open the main air valve between the air chamber and measuring bowl. Tap the sides of the measuring bowl smartly with the mallet. Lightly tap the pressure gauge by hand to stabilize the gauge hand. (Para. 8.3.2)

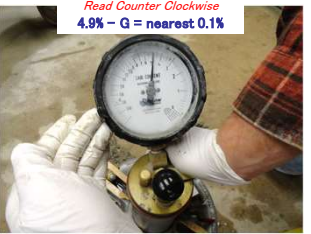
14. Read the percentage of air on the dial of the pressure gauge. (Para. 8.3.2)





Takes 3 hands to read gauge!

Read Counter Clockwise
4.9% - G = nearest 0.1%

15. Release the main air valve. Release the pressure in the bowl by opening both petcocks before removing the cover. (Para. 8.3.2)

16. Report the air content to the nearest 0.1% using the aggregate correction factor (or to the nearest 1/2 scale division if the gauge reading exceeds 8%). (Para. 10.1.1)



$A_s = A_1 - G$ Eq. 5

Where (Para. 9)
 A_s = air content of sample tested, %
 A_1 = apparent air content of sample tested (meter reading), %
 G = aggregate correction factor, % (computed from aggregates)

Example
 $A_1 = 4.9\%$
 $G = 0.1\%$ from Para. 6.1 (computed by filling meter with aggregates in same portions as mix and run air test)

**$A_s = 4.9\% - 0.1\%$
 $A_s = 4.8\%$**

Typically, WY aggregates have an aggregate correction factor of 0.0% (very dense aggregates)

2-49

Making/Curing Cylinders & Beams
ASTM C31



WYDOT's default size is 4" x 8"

2-50

Notes

Concrete strength test specimens must be made according to Practice C31 for two reasons:

- 1) So that the results are reliable
- 2) So that the test can be reproduced by someone else with the same concrete, following the same procedure and getting (nearly) the same results.

Specimens must be molded—that is, filled and compacted—according to standard procedures. Then, they must be cured under proper temperature and moisture conditions.

For example, specimens improperly cured between 90 to 100°F will develop strength at a different rate than specimens cured at the specified initial temperature range of 60 to 80°F required by Practice C31.

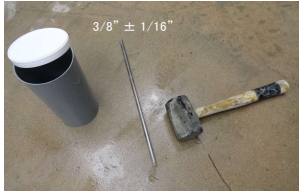

5.4 Tamping Rod A round, smooth, straight, steel rod with a diameter conforming to the requirements in Table 1. The length of the tamping rod shall be at least 4 in. greater than the depth of the mold in which rodding is being performed, but not greater than 24 in. in overall length (The rod shall have the tamping end or both ends rounded to a hemispherical tip of the same diameter as the rod.)

TABLE 1 Tamping Rod Diameter Requirements

Diameter of Cylinder or Width of Beam mm [in.]	Diameter of Rod mm [in.]
$\le 150 [6]$	$10 \pm 2 [3/8 \pm 1/16]$
> 150 [6]	$16 \pm 2 [5/8 \pm 1/16]$

5.6 Mallet A mallet with a rubber or rawhide head weighing 1.25 ± 0.50 lb shall be used.

5.8 Finishing Tools A handheld float or a trowel.

6.1 Cylindrical Specimens
When the nominal maximum size of the coarse aggregate exceeds **2 in.**, the concrete sample shall be treated by wet sieving through a **2 in.** sieve as described in Practice C172. For acceptance testing for specified compressive strength, cylinders shall be 6 x 12 in. or by 4 x 8 in.

6.2 Beam Specimens
6.2.2 When the nominal maximum size of the coarse aggregate exceeds **2 in.**, the concrete sample shall be treated by wet sieving through a **2 in.** sieve as described in Practice C172.

8. Slump, Air Content and Temperature
 8.1 Measure & record slump
 8.2 Determine & record air content
 8.3 Determine & record temperature } by ASTM C31

WYDOT – Determine & record density

2-52

1.2 The concrete used to make the molded specimens shall be sampled **after all on-site adjustments have been made to the mixture proportions, including the addition of mix water and admixtures.**

9.0 Molding Specimens

1. Place of Molding Mold specimens promptly on a level, rigid surface, free of vibration and other disturbances, at a place as near as practicable to the location where they are to be stored.
2. Use a scoop to place concrete in the mold. Use care to distribute the material evenly around the perimeter of the mold. (Para. 9.2)
3. **For the first layer:**
 - A. Fill the mold with the appropriate quantity of concrete: approximately 1/2 the volume for a 4 by 8 in. mold. (Para. 9.2, Table 4, and 9.4.1)
 - B. Rod the layer 25 times, uniformly over the cross section, with the rounded end of the rod. Rod the layer throughout its depth using care not to damage the bottom of the mold. (Para. 9.4.1)



- C. Tap the outsides of the mold lightly 10 to 15 times with the mallet to close any holes left by rodding and to release any large air bubbles that may have been trapped. Use an **open hand to tap cylinder molds that are susceptible to denting or other permanent distortion** if tapped with a mallet. (Para. 9.4.1)

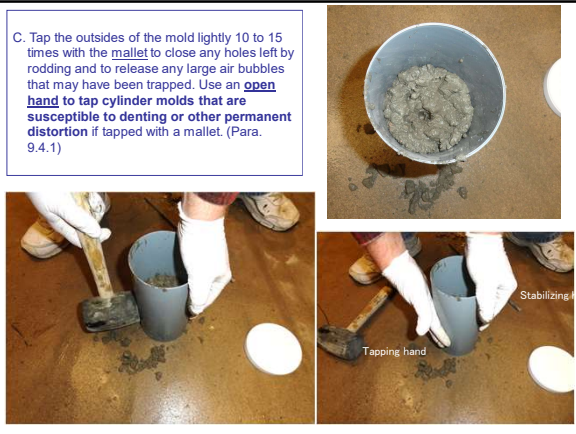

4. For the second layer:
A. Fill the mold with the appropriate quantity of concrete: fill a 4 by 8 in. mold to the top. (Para 9.2 Table 4, and 9.4.1)
B. Rod the layer 25 times, uniformly over the cross section, with the rounded end of the rod. Rod through the layer and into the layer below approximately 1 in. (Para. 9.4.1)



C. Tap the outsides of the mold lightly 10 to 15 times with the mallet to close any holes left by rodding and to release any large air bubbles that may be trapped. Use an open hand to tap cylinder molds that are susceptible to denting or other permanent distortion if tapped with a mallet. (Para. 9.4.1)



5. During consolidation of the top layer, adjust the concrete level of underfilled and overfilled molds, if necessary. (Para. 9.4.1)
6. Strike off any excess concrete with the tamping rod, or with a handheld float or trowel if appropriate, to produce a flat even surface. (Para. 9.5.1)



9.5 Finishing Perform all finishing with the minimum manipulation necessary to produce a flat even surface that is level with the rim or edge of the mold and that has no depressions or projections larger than 1/8 in.

- 7. Provide protection to prevent sample moisture loss. (Para. 10.1.2.2)
- 8. What must be done after finishing the specimen?
 - Mark the specimen to identify the concrete it represents (Para. 9.6)
 - Move the specimen to an initial curing place for storage (Para. 10.1.1)





Max. departure from perpendicularity: 0.5 degrees of 1/8" in 12"
(For your info only – NOT on TEST)

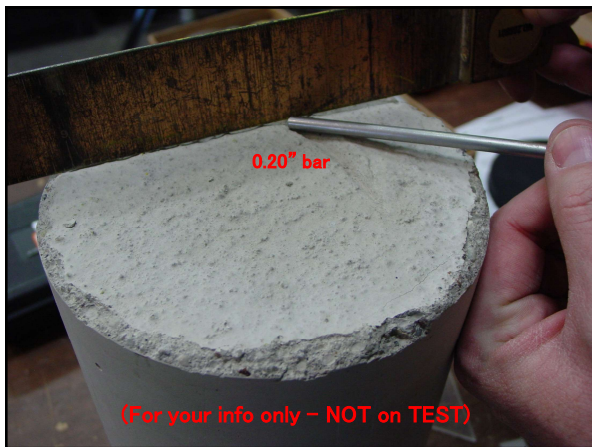

(For your info only – NOT on TEST)

Initial & Final Cure of Cylinders



Types of Curing

- **Standard Curing** (Specified Temperatures)
 - Initial Curing (First 48 hrs.)
 - Final Curing (Balance of 28 days)
- **Field Curing** (Cured same as concrete they represent)

2-61

Curing Cylinders

10. Curing

10.1 Standard Curing Standard curing is the curing method used when the specimens are made and cured for the purposes stated in 4.2.

10.1.1 Storage The supporting surface on which specimens are stored shall be level to within 1/4 in./ft. If specimens are not molded in the location where they will receive initial curing, ensure that the specimens have been moved to the initial curing location no later than 15 min after molding operations have been completed. If a specimen in a single-use mold is moved, support the bottom of the mold. If the top surface of a specimen is disturbed during movement to the place of initial storage, refinish the surface.

10.1.2 Initial Curing Store standard-cured specimens for a period up to 48 h after molding to maintain the specified temperature and moisture conditions described in 10.1.2.1 and 10.1.2.2

10.1.2.1 For concrete mixtures with a specified strength less than 6000 psi, maintain the initial curing temperature between 60 and 80°F.

For concrete mixtures with a specified strength of 6000 psi or greater, maintain the initial curing temperature between 68 and 78°F.

Shield specimens from direct exposure to sunlight and, if used, radiant heating devices. **Record the minimum and maximum temperatures** achieved for each set of specimens during the initial curing period.

10.1.3 Final Curing

10.1.3.1 Cylinders—Upon completion of initial curing and within 30 min after removing the molds, cure specimens with free water maintained on their surfaces at all times at a temperature of 73.5 ± 3.5°F using water storage tanks or moist rooms.

2-62

10.2 Field Curing

10.2.1 Cylinders Store cylinders in or on the structure as near to the point of deposit of the concrete represented as possible. **Protect all surfaces of the cylinders from the elements in as near as possible the same way as the formed work.** Provide the cylinders with the same temperature and moisture environment as the structural work.

11. Transportation of Specimens to Laboratory Specimens shall not be transported until at least after final set. During transporting, protect the specimens with suitable cushioning material to prevent damage from jarring. **During cold weather, protect the specimens from freezing with suitable insulation material.** Prevent moisture loss during transportation by wrapping the specimens in plastic, wet burlap, by surrounding them with wet sand, or tight fitting plastic caps on plastic molds.

Standard Cured Specimens

Used for concrete strength acceptance.

Field Cured Specimens

Used to make decision when formwork, shoring and reshoring can be removed. Also to determine when a structure is capable of being placed into service. (4.2 & 4.3)

Question: Is it appropriate to use standard cured specimens to determine when it is okay to remove formwork and shoring?

Answer: NO! NO! NO! — NEVER! — SAFET FIRST —

2-63

Cylinder Testing



2-64

Compressive Strength

- Standard cylinder 6" x 12"
- Measured at 28 days (3, 7, 14 days)
- Typical range
3,000 psi to 5,000 psi
- $f'_c = P_{max} / Area$ lbs/sq. inch or psi

Example: $P = 100,036$ lbs

$P = 100,036$ lbs
 $A = \pi r^2 = \pi (3)^2 = 28.2$ in²
 $f'_c = \frac{P}{A} = \frac{100,036 \text{ lbs}}{28.2 \text{ in}^2} = 3550$ psi



2-65

Beams – ASTM C31



- Place molds on a level, rigid, horizontal surface free of vibration. (Para 9.1)
- Determine number of rodding — one per layer for each 2 sq.in. (Para 9.3)
 $(6" \times 20")/2 = 60$ rods per layer
- Place concrete in the mold, moving a sloop around the top edge to ensure even distribution of the concrete. (Para. 9.3)
- Fill the mold in two equal layers, attempting to fill the mold after consolidation on the last layer. (Para. 9.4, see Tables 2, 3 & 4)
- Rod each layer 60 times with rounded end of 5/8-in. rod, uniformly distributing strokes. (Para. 9.4.1, Table 3)

2-66

6. Rod bottom layer throughout its depth. (Para 9.4.1)
7. Rod the second layer to a depth of 1-inch into the underlying layer. (Para. 9.4.1)
8. Tap the sides of the mold lightly 10–15 times with mallet after rodding each layer. (Para. 9.4.1)
9. After tapping, spade concrete along sides and ends with a trowel or other suitable tool. (Para. 9.4.1)
10. Strike off the surface and float or trowel as required to produce a flat even surface that is level with edge of mold and has no depressions or projections larger than 1/8-in. (Para. 9.5)
11. Mark specimens to identify, don not alter top surface. (Para. 9.6)
12. Protect specimens and promptly begin either standard or field cure. (Para 10)

2-67



2-68



39





